

PRIKLJUČCI S PREDMONTIRANIM ČAHURAMA ZA VISOKOTLAČNE GUMENE CIJEVI "MANULI" REFRIFAST ZA FREON (KLIMA MOTORNIH VOZILA)

TIP | STANDARD | NAPOMENA

CFR UNF/UNS RF + čahura	-	s O-ringom
CFR UNF 5/ 8" - NP 8 RF + čahura		
CFR UNF 3/ 4" - NP 10 RF + čahura		
CFR UNF 7/ 8" - NP 13 RF + čahura		
CFR UNF 7/ 8" - NP 16 RF + čahura		
CFR UNS1" - NP 10 RF + čahura		
CFR UNS1" - NP 13 RF + čahura		
CFR UNS1" - NP 16 RF + čahura		
CFR UNS1. 1/16" - NP 16 RF + čahura		

CFR UNF/UNS L45 RF + čahura	-	s O-ringom
CFR UNF 5/ 8" L45 NP 8 RF + čahura		
CFR UNF 3/ 4" L45 NP 10 RF + čahura		
CFR UNF 7/ 8" L45 NP 13 RF + čahura		
CFR UNS1" L45 NP 10 RF + čahura		
CFR UNS1" L45 NP 13 RF + čahura		

CFR UNF/UNS L90 RF + čahura	-	s O-ringom
CFR UNF 5/ 8" L90 NP 8 RF + čahura		
CFR UNF 3/ 4" L90 NP 10 RF + čahura		
CFR UNF 7/ 8" L90 NP 13 RF + čahura		
CFR UNF 7/ 8" L90 NP 16 RF + čahura		
CFR UNF1" L90 NP 10 RF + čahura		
CFR UNF1" L90 NP 13 RF + čahura		
CFR UNF1" L90 NP 16 RF + čahura		
CFR UNS1. 1/16" L90 NP 16 RF + čahura		

DFR UNF/UNS RF + čahura	SAE J512	unutarnji konus tijela glave 90
DFR UNF 5/ 8" - NP 8 RF + čahura		
DFR UNF 3/ 4" - NP 10 RF + čahura		
DFR UNF 7/ 8" - NP 13 RF + čahura		
DFR UNS1. 1/16" - NP 16 RF + čahura		

DFR UNF L45 RF + čahura	SAE J512	unutarnji konus tijela glave 90
DFR UNF 5/ 8" L45 NP 8 RF + čahura		
DFR UNF 3/ 4" L45 NP 10 RF + čahura		
DFR UNF 7/ 8" L45 NP 13 RF + čahura		

DFR UNF L90 RF + čahura	SAE J512	unutarnji konus tijela glave 90
DFR UNF 5/ 8" L90 NP 8 RF + čahura		
DFR UNF 3/ 4" L90 NP 10 RF + čahura		
DFR UNF 7/ 8" L90 NP 13 RF + čahura		

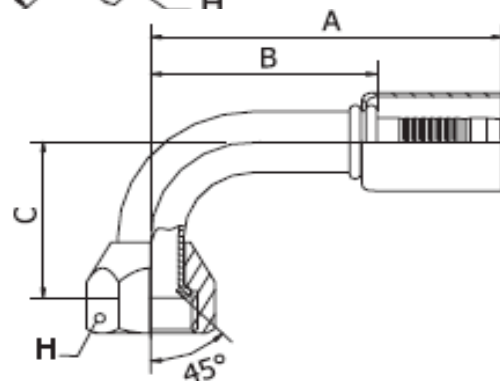
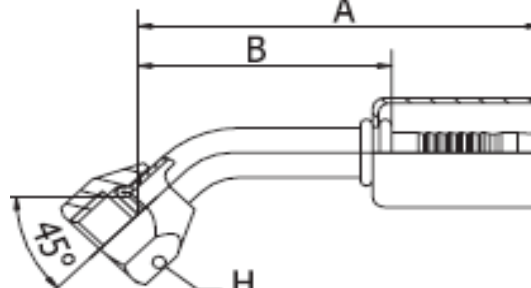
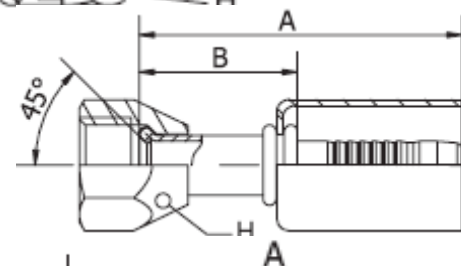
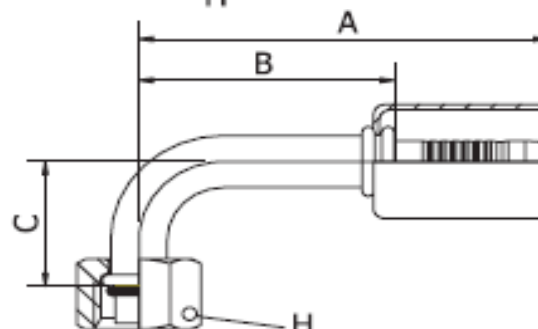
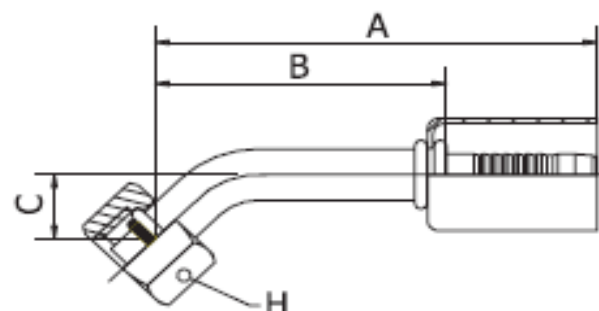
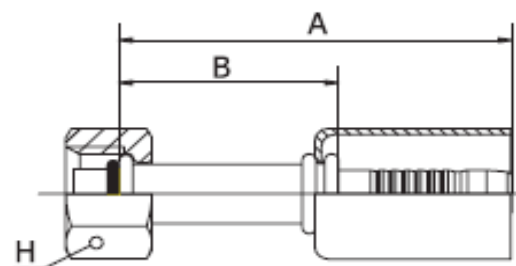

NP RF - NP RF + čahure	-	za produženje cijevi
NP 8 RF - NP 8 RF + čahure		
NP 10 RF - NP 10 RF + čahure		
NP 13 RF - NP 13 RF + čahure		
NP 16 RF - NP 16 RF + čahure		

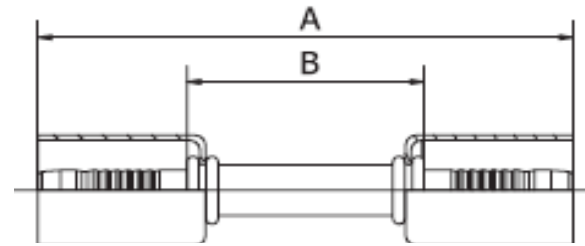

NP RF L90 NP RF + čahure	-	za produženje cijevi
NP 8 RF L90 NP 8 RF + čahure		
NP 10 RF L90 NP 10 RF + čahure		
NP 13 RF L90 NP 13 RF + čahure		

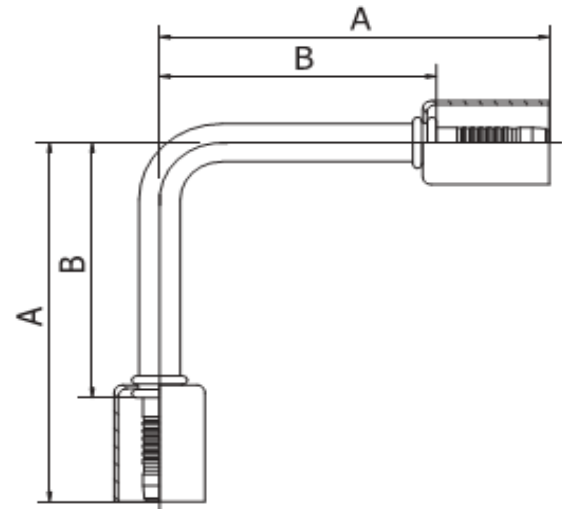

- Napomene:**
- Obzirom da nazivni unutarnji promjer cijevi za freon NP 10 nije proistekao od colne veličine 3/8" već od 13/32", analogne su veličine i prije navedenih nogica.
 - Priključci sa glavama tipa CFR i DFR imaju navoj 1.1/16" prema UNS standardu sa korakom 14 za razliku od priključaka sa standardnim glavama koje imaju navoj te veličine prema UN standardu sa korakom 12.
 - Po posebnoj narudžbi je moguće isporučiti pojedine od prije navedenih priključaka sa ugrađenim niskotlačnim (NT) ili visokotlačnim (VT) ventilom.
 - Minimalna količina za naručivanje je 30 kom po vrsti i veličini.